



SECURITY'LIGHT  
connected camera concept

---

**VESTA**  
5190601118  
ST1906-CAM



**LUTEC**  
CONNECTED BY LIGHTING

# Contents

---

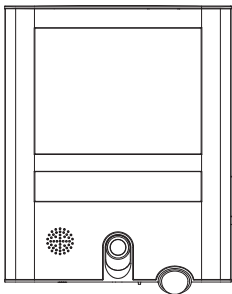

x 1



x 1

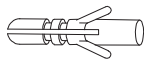

x 2



x 2



x 1



x 1



# Introduction

INCL.  
220-240V  
~50/60Hz  
LED 30W



IP54

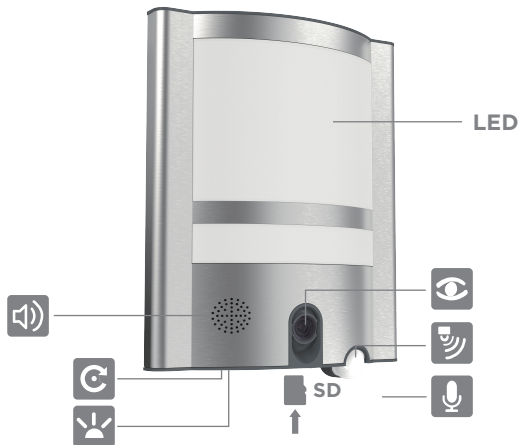

Reset  
Réinitialiser  
Reset  
Ripristino  
Reiniciar  
Reset  
Törlés  
Reset



Camera  
Camera  
Kamera  
Telecamera  
Cámara  
Camera  
Kamera  
Kamera



Microphone  
Micro  
Mikrofon  
Microfono  
Microfono  
Microfoon  
Mikrofon  
Mikrofon



Loudspeaker  
Haut parleur  
Lautsprecher  
Altoparlante  
Altavoz  
Luidspreker  
Hangszoró  
Głośnik



Sensor  
Capteur  
Bewegungsmelder  
Sensore  
Sensor  
Sensor  
Mozgásérzékelő  
Czujnik



Indicator light  
Témoin lumière  
Anzeigenleuchte  
Luce indicatore  
Luz indicadora  
Indicatielampje  
Visszajelző fény  
Lampka kontrolna

# Pre-installation

1



- Download the APP.
- Télécharger l'application.
- Laden Sie die APP herunter.
- Scaricare l'APP.
- Descargar la APP.
- Download de APP.
- Töltse le az applikációt.
- Pobierz aplikacje.

2



SECURITY'LIGHT

- Ensure **SECURITY'LIGHT** location has good Wi-Fi reception.
- S'assurer de la qualité de réception du WI-FI à l'emplacement du **SECURITY'LIGHT**.
- Stellen Sie sicher, dass die **SECURITY'LIGHT** Leuchte einen guten Wi-Fi-Empfang hat.
- Assicurarsi che la **SECURITY'LIGHT** sia in una posizione con buona ricezione Wi-Fi.
- Asegúrese de que **SECURITY'LIGHT** tiene buena recepción de Wi-Fi.
- Zorg ervoor dat de locatie van de **SECURITY'LIGHT** een goede WiFi ontvangst heeft.
- Győződjön meg róla, hogy a **SECURITY'LIGHT** jó Wi-Fi vétellel rendelkezzon
- Upewnij się **SECURITY'LIGHT** dobrze odbiera sygnał Wi-Fi.

# Maintenance

- Wipe the camera regularly.
- Nettoyer régulièrement la camera
- Säubern Sie die Kamera regelmäßig.
- Spolverare la telecamera regolarmente.
- Limpie la cámara regularmente.
- Veeg de camera regelmatig schoon.
- Tisztítsa meg rendszeresen a kamera optikáját
- Przecieraj kamere regularnie.



- Via the "Support" button you can access to all further questions.
- Pour toute question complémentaire, touchez « Support ».
- Über den Button "Support" in der App finden Sie weitere Hinweise.
- Tramite il tasto "Support" puoi avere accesso a tutte le altre informazioni
- Mediante el botón de "Support" se puede acceder a las preguntas.
- Via de "Support" toets kan je toegang krijgen tot alle verdere informatie.
- A support/támogatás gomb segítségével minden további kérdésre választ kaphat.
- Poprzez guzik „Pomoc” możesz mieć dostęp do wszystkich dalszych pytań.

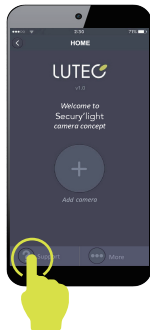



**SECURITY'LIGHT**  
connected camera concept

*«When light meets a camera,  
when light means security»*

**Service:**

**LUTEC in FRANCE**

+33-04-75602598

**LUTEC in IBERIA**

+34-93-5001221

**LUTEC in ROMANIA**

+40-234-562-452

**LUTEC in UKRAINE**

+38-044-496-74-83

**LUTEC Europe NV**

Ruiterijschool 14 B-2930 Brasschaat - Belgium  
+32 3 284 51 62

**For more information, please visit:**

[www.lutec.com/services/global-network](http://www.lutec.com/services/global-network)

**LUTEC in UK**

+44 (0) 1992-760870

**LUTEC in BNL**

+ 32 (0) 3-454-01-09

**LUTEC in RUSSIA**

+7-499-5501529

**LUTEC in DACH-ECO-LIGHT Leuchten GmbH**

+49-228-9691090 Böheler Weg 27 - D-53347 Alfter

**LUTEC in ITALY**

+39-031-3551342

**LUTEC in HUNGARY**

+36-30-2193952

**LUTEC in GREECE**

+30-2104820946

**LUTEC**

CONNECTED BY LIGHTING

# Installation

---

① OFF

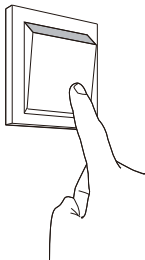

②

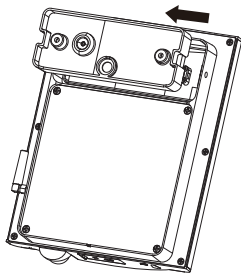
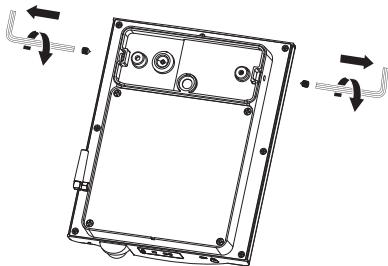

③

# Installation

4

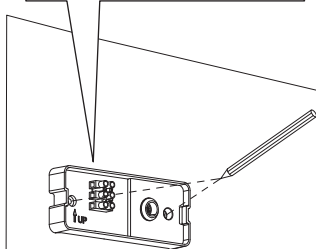
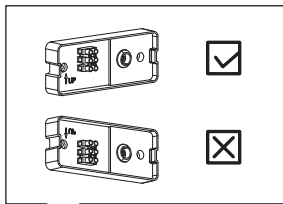
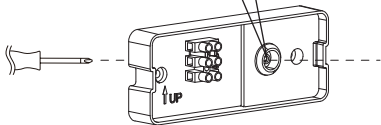
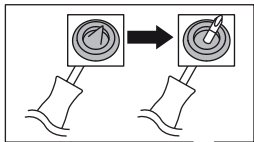

5

# Installation

6

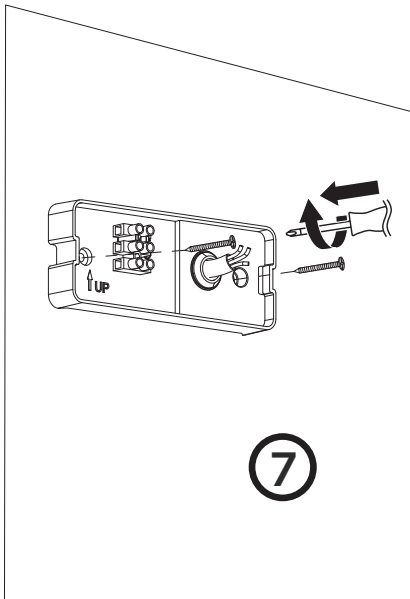
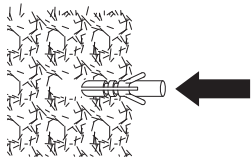
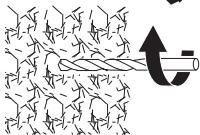

7

# Installation

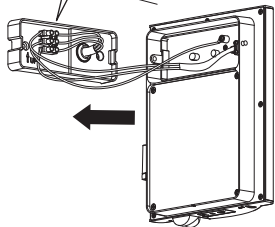
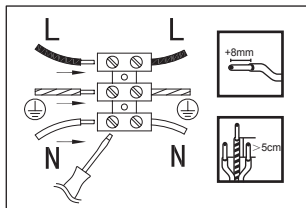

8

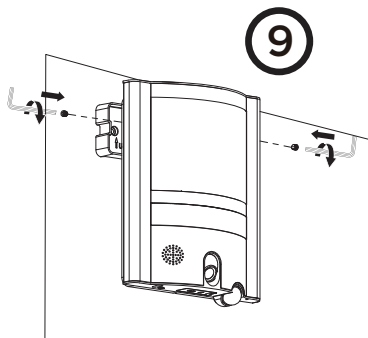

ON

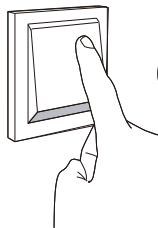



# Adjustment

---

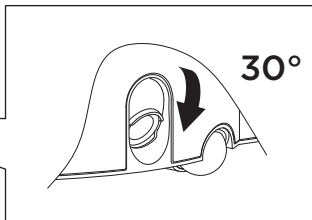
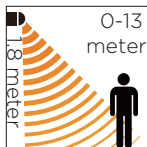
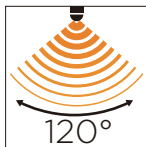
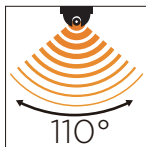
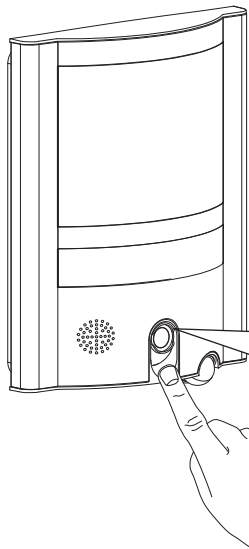

# Set up



- Start set up when red indicator flashes.
- Commencer à configurer quand le témoin rouge clignote.
- Starten Sie die Installation während die rote Led blinkt.
- Mentre spia rossa è lampeggiante inizia a impostare.
- Inicie la configuración mientras el indicador rojo parpadee.
- Start de configuratie wanneer het rode lampje knippert.
- Kezdje el a beállításokat, ha a piros visszajelző fény villog
- Rozpocznij konfiguracje kiedy czerwona lampka świeci.

