



Gebruiksaanwijzing
Notice d'emploi
Benutzerhandbuch
User manual
Manual de usuario

17406/**/P0

17405/**/P0



PHILIPS

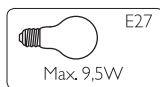
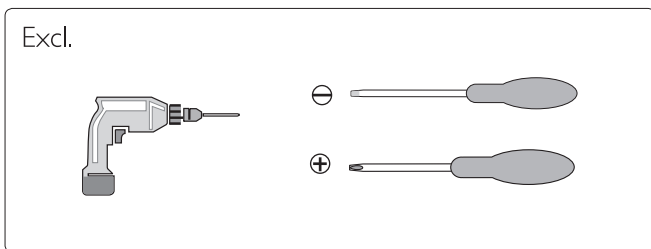
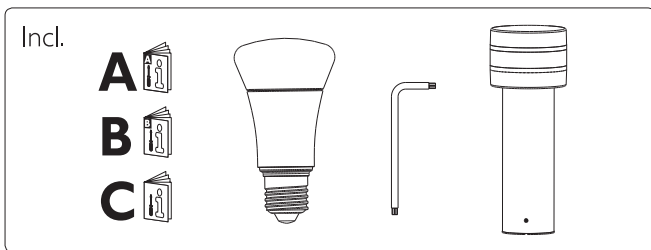

www.meethue.com/getstarted



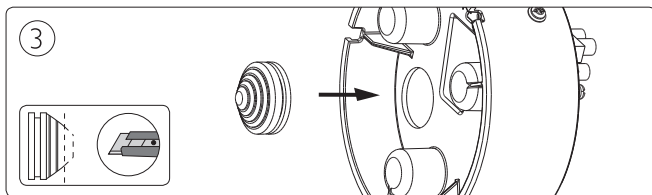
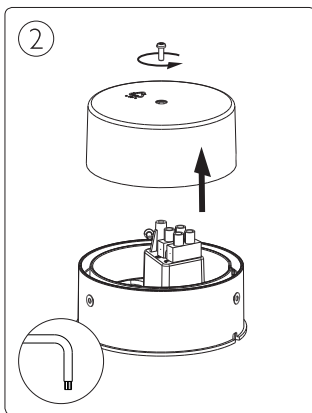
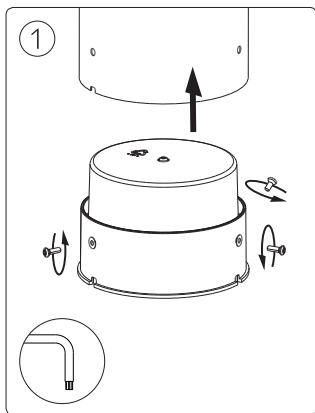
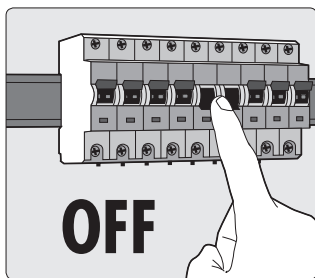

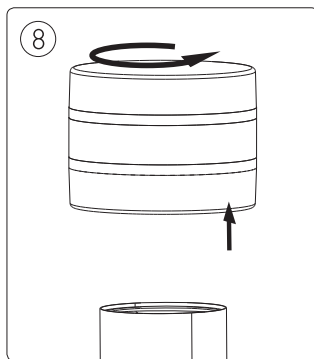
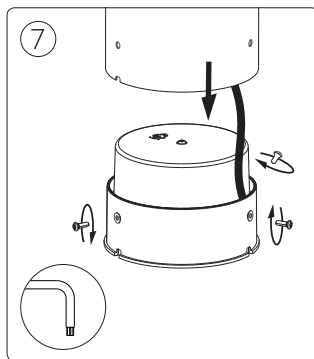
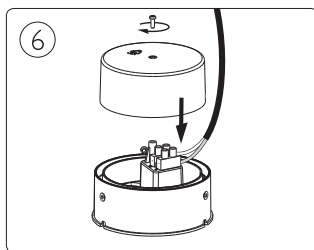
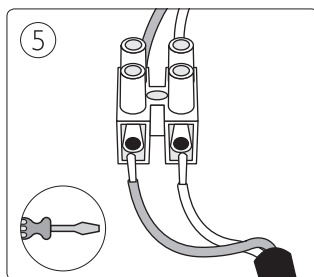
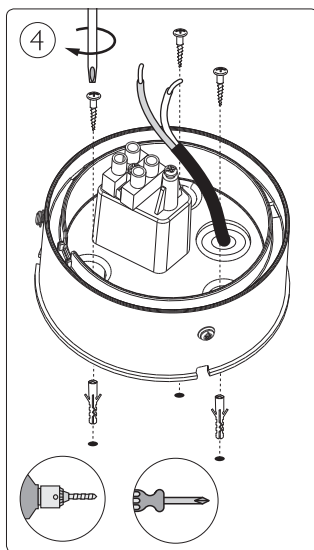

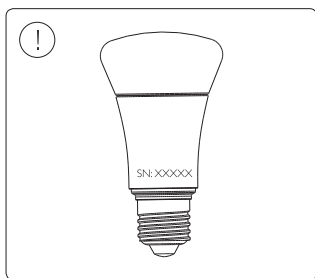
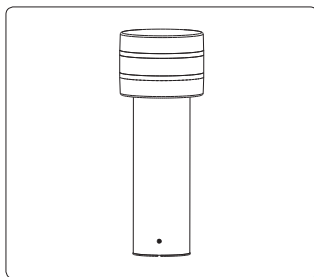
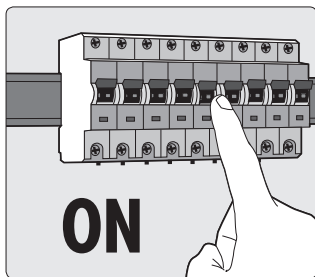
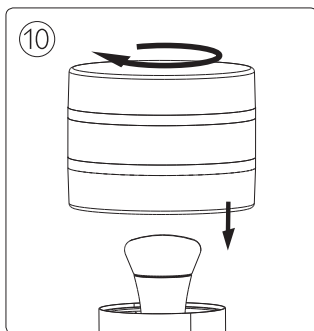
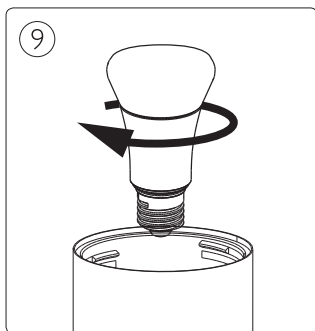



Philips Lighting Contact Centre
Int. Business Reply Service
I,B,R,S. / C,C,R,I, Numéro 10461
5600 VB Eindhoven
Pays-Bas / The Netherlands

www.meethue.com/getstarted
www.philips.com
☎ +800 7445 4775

440402909141
Last update: 24/11/17